

Zubehör / Accessories

- **Verstärkte Hutmutter aus Nylon für Gewinde M12**
Reinforced cap nut of nylon for Screw-thread M12

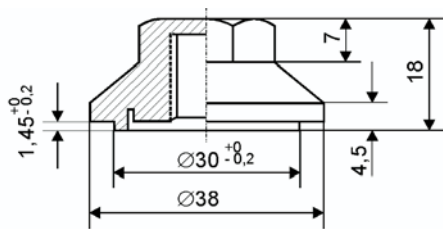
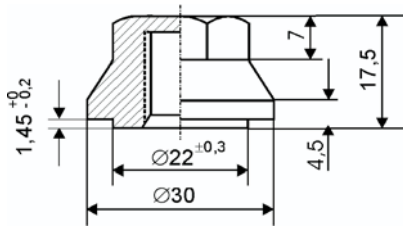

Bestellbezeichnung / Product code: CNN30M12 (für / for Ø 30mm, Standard)
CNN38M12 (für / for Ø 38mm)

- **Isolierscheibe aus Vestolen PP für Ø77mm und Ø90mm**
Insulating washer of vestolen PP for Ø77mm and Ø90mm

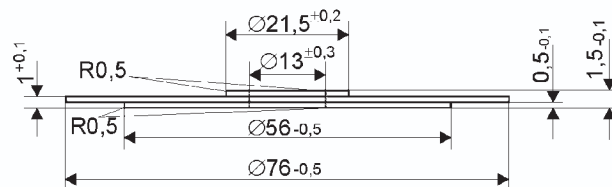
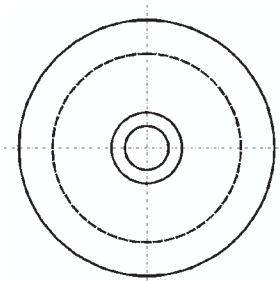

Bestellbezeichnung / Product code: K100 – ISO – 77 – 13

- **Isolierscheibe aus Vestolen PP für Ø51mm und Ø64mm**
Insulating washer of vestolen PP for Ø51mm and Ø64mm

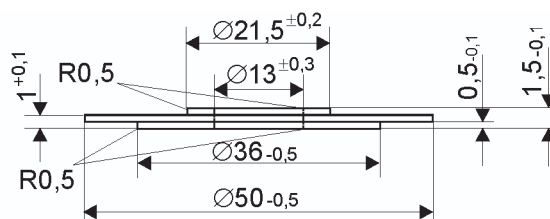
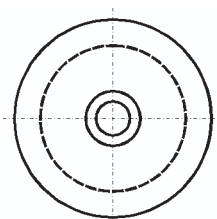

Bestellbezeichnung / Product code: K100 – ISO – 50 – 13

Zubehör / Accessories

► Einpressring aus Escorene LDPE zur Befestigung Press ring of escorene LDPE for mounting

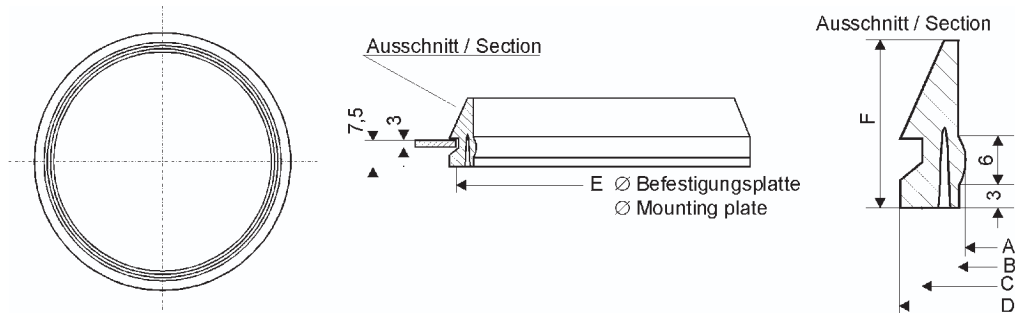

| Ø Kondensator Ø Capacitor | A ^{+0,3} | B ^{+0,3} | C ^{+0,3} | D ^{+0,3} | E ^{+0,2} | F ^{+0,2} | Bestellbezeichnung Product code |
|------------------------------|-------------------|-------------------|-------------------|-------------------|-------------------|-------------------|------------------------------------|
| 77 | 74,8 | 76,8 | 84,0 | 88,5 | 85,0 | 20,0 | K100 – 77 |
| 90 | 87,5 | 98,5 | 97,8 | 102,0 | 98,5 | 25,0 | K100 – 90 |

► Distanzkappe für Anschlüsse M5 aus AlMgSi₁ (Nur für die Serien FX2, GX2 und GXH) Spacer cap for M5 terminal of AlMgSi₁ (Only for series FX2, GX2 and GXH)



Bestellbezeichnung / Product code: SC3 – 14M5

